

Type-C->USB

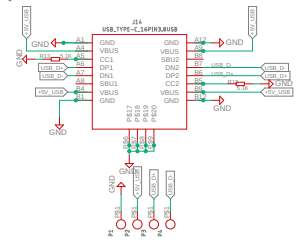

Type-C->URAT0

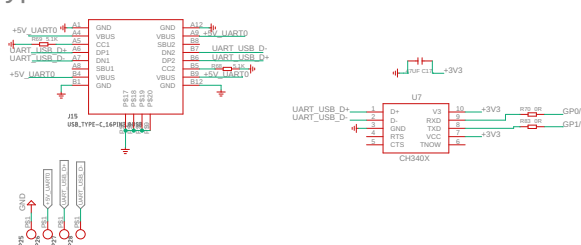

RP2040_MCU MIN System

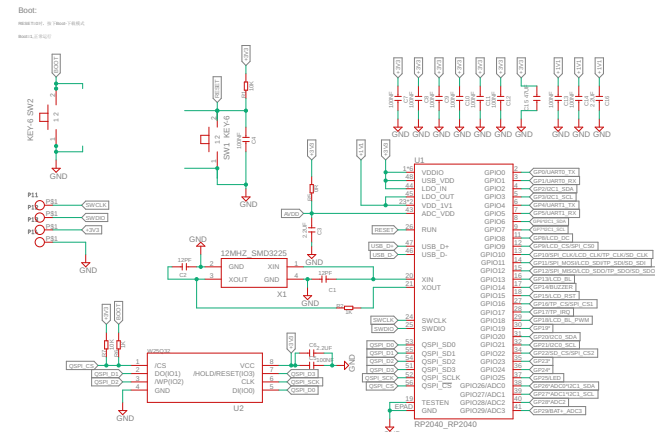

电池及充电电路

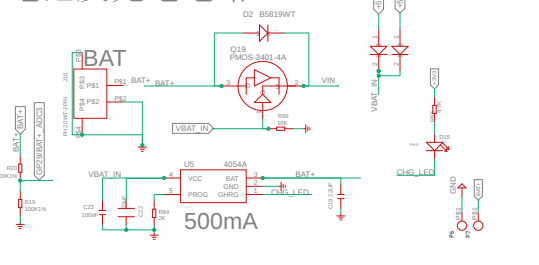

POWER

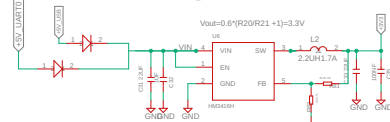

TF Card

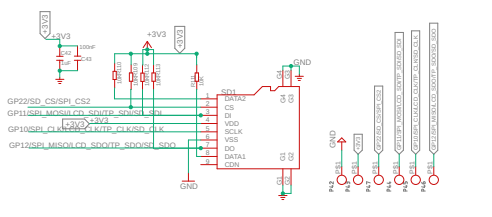

Buzzer

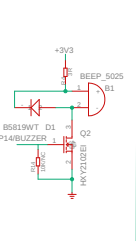

LED Indicator

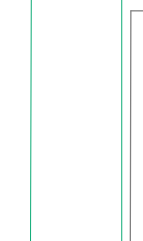

LCD+TP 接口

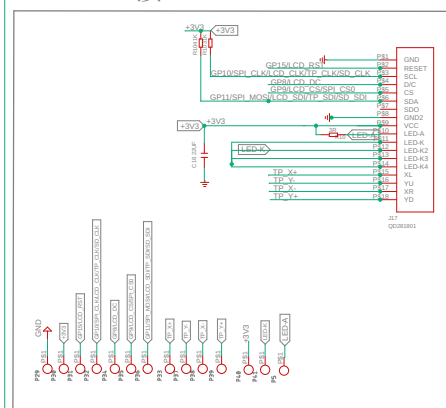

LCD 背光

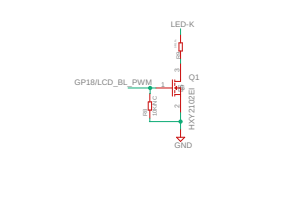

I2C0接口

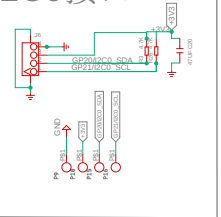

UART1接口

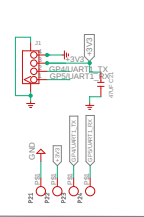

螺母

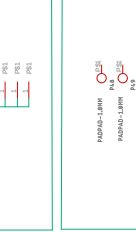

Mark

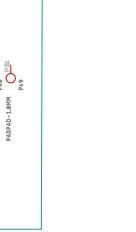

3.3V电源, GPIO引脚

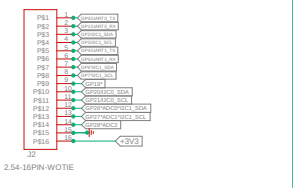

TP驱动:XPT2046

